

① 1 4 5 6

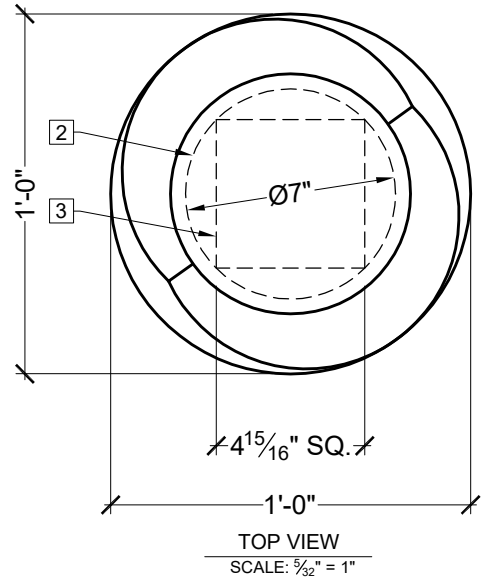
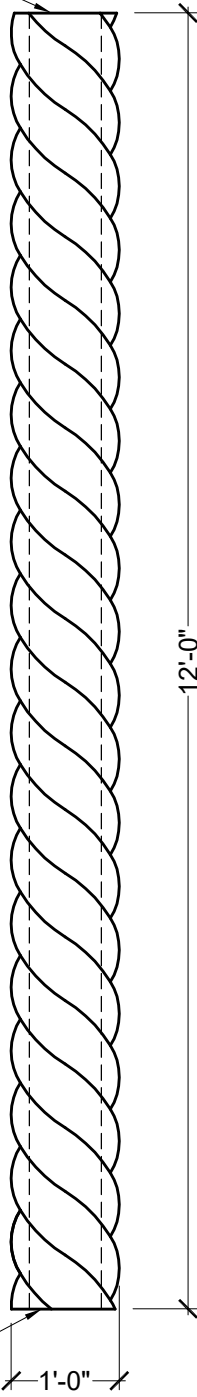

Confirm For Correctness
& Fax Back Within 24 Hrs.
To (204) 388-6710
Your Signature: _____

BILL OF MATERIAL

- ① CLM400-12-12 - NON-STRUCTURAL COLUMN MADE OF POLYURETHANE AND/OR PVC AT SPECTIS' DISCRETION.

OPERATIONS

- ① UNFINISHED TOP AND BOTTOM.
- ② MAXIMUM ROUND INTERNAL MEMBER SIZE.
- ③ MAXIMUM SQUARE INTERNAL MEMBER SIZE.
- ④ INTERIOR HOLLOW WITH OPEN TOP/BOTTOM.
- ⑤ CAN BE SHIPPED SPLIT OR ASSEMBLED AT CUSTOMER'S REQUEST UPON ORDERING.
- ⑥ IF SPLIT, ASSEMBLED AND PATCHED ON SITE BY OTHERS.

GENERAL NOTES:

-ALL CUSTOM MANUFACTURED AND/OR MODIFIED STANDARD PRODUCTS ARE NON-RETURNABLE.

-SPECTIS ADHESIVE MUST BE USED ON ALL BEDDING/BUTT JOINTS.



SPECTIS™
MOULDERS INC.
Custom Polyurethane Products

BOX 479
PEMBINA,
NORTH DAKOTA
58271-0479
11 C A

P.O. BOX 970
100 CEDAR DRIVE
NIVERVILLE, MANITOBA
CANADA R0A 1E0

PHONE: 204-388-6700
PHONE: 800-685-9981
FAX: 204-388-6710

GENERAL NOTES:

- 1. ALL PRODUCTS ARE DRAWN FOR PRESENTATION PURPOSES ONLY. IMAGE MAY VARY SLIGHTLY FROM ACTUAL PART
- 2. DRAWING INTENT IS TO INDICATE GENERAL ARRANGEMENT. DESIGN AND INTENT OF WORK IS PARTLY DIAGRAMMATIC.
- 3. SPECTIS RESERVES THE RIGHT TO CHANGE ANY PRODUCT DESIGN WITHOUT NOTICE.

CUSTOMER NAME: STANDARD PRODUCT		PART: CLM400-12-12	
REFERENCE: COLUMN		SHEET: 01 OF 01	
DRAWN BY: JK	DATE: 01/30/18	SCALE: 3/64" = 1"	REV: